

Design of Semi pucca house (2 Room) With Kitchen & Toilet

Estimated Cost: Taka 1,71,000.00

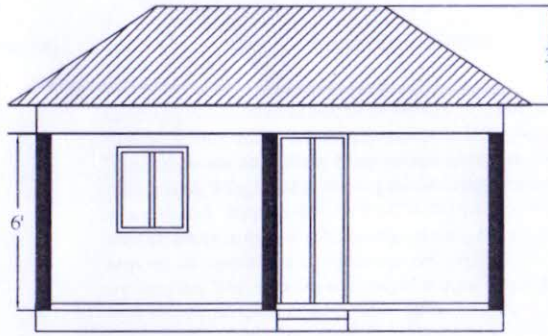

ELEVATION

SEMI PUCCA HOUSE ON OWNER'S LAND

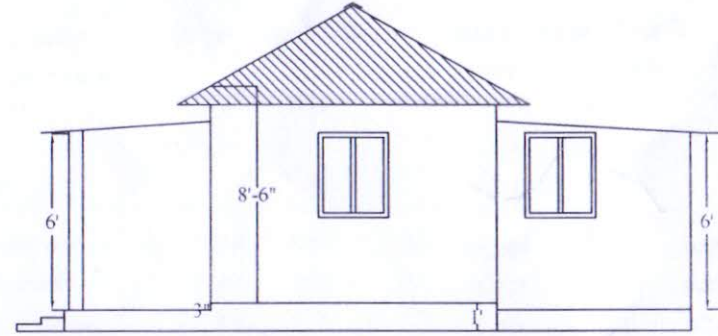

RIGHT SIDE ELEVATION

[Signature]

মোঃ মাহবুব হোসেন
প্রকল্প পরিচালক (অতিরিক্ত সচিব)
আশ্রয়ণ-২ প্রকল্প
প্রধানমন্ত্রীর কার্যালয়

[Signature]
08.10.20
মোঃ ইবতিয়াক নাসির
সহকারী প্রকৌশলী
আশ্রয়ণ-২ প্রকল্প
প্রধানমন্ত্রীর কার্যালয়

08.10.20
হিমাত্রি সাহা
সহকারী প্রকৌশলী
আশ্রয়ণ-২ প্রকল্প
প্রধানমন্ত্রীর কার্যালয়

[Signature]
08.10.20

মোঃ রফিকুল ইসলাম
সহকারী প্রকৌশলী
আশ্রয়ণ-২ প্রকল্প
প্রধানমন্ত্রীর কার্যালয়

[Signature]
08.10.20
মোঃ আনোয়ার রহমান
উপ-প্রকল্প প্রকৌশলী
আশ্রয়ণ-২ প্রকল্প
প্রধানমন্ত্রীর কার্যালয়

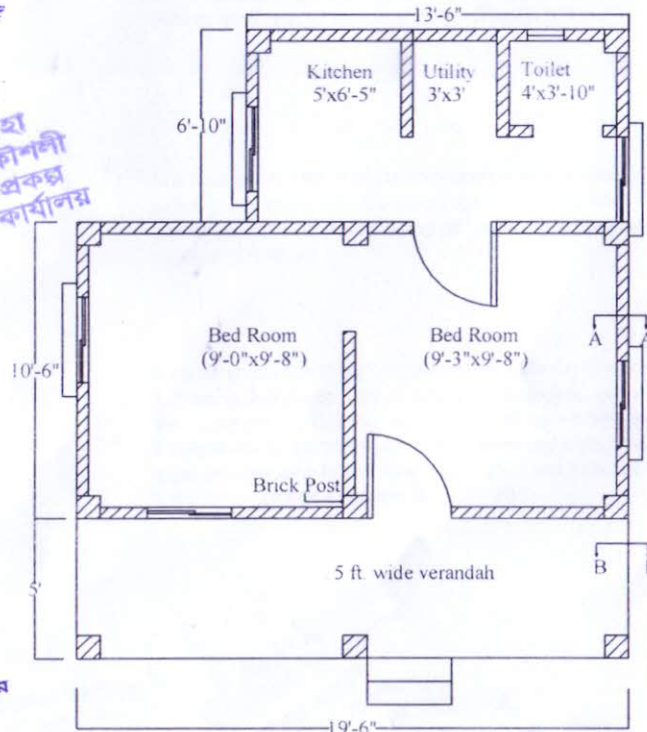

PLAN

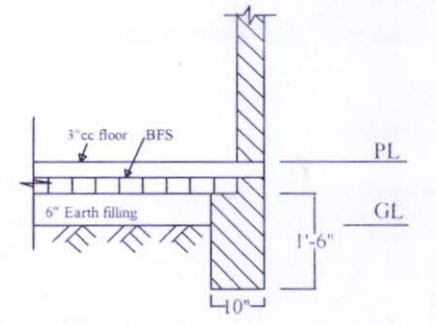

Section-A-A

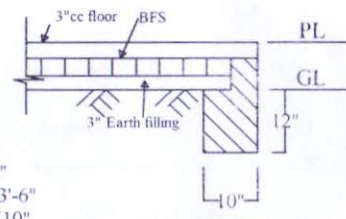

Section-B-B

Door- 3'-0"X6'-0"
Window- 2'-6"X3'-6"
Brick Post- 10"X10"

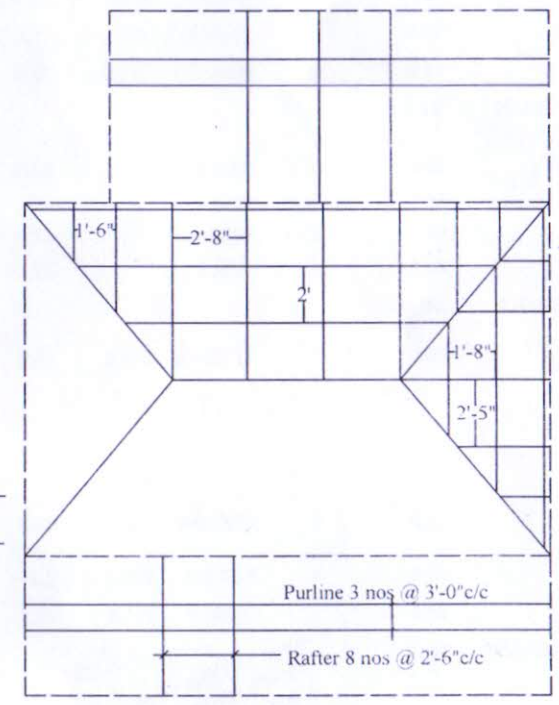

Rafter & Purline Details

[Signature]
08/10/20
আবুল কালাম আজাদ
প্রকল্প প্রকৌশলী
আশ্রয়ণ-২ প্রকল্প
প্রধানমন্ত্রীর কার্যালয়

[Signature]
08/10/20

মোঃ মাহবুব হোসেন
প্রকল্প পরিচালক (অতিরিক্ত সচিব)
আশ্রয়ণ-২ প্রকল্প
প্রধানমন্ত্রীর কার্যালয়

Detail estimate of Semi pucca house (2 Room) with Kitchen & Toilet

(Based on PWD rate schedule-2018 & Market price)

SL	Item Code No.	Description of Work	Unit	Location / Component	Length	Width	Height / Depth	Area / Volume	No of	Total Qty of Works	Unit Rate	Amount
1	PWD CES 02.1.2	Earthwork in excavation of foundation trenches, including layout, by excavating earth to the lines, grades and elevation as shown in the drawing providing center lines, local bench mark pillars, fixing bamboo spikes and marking layout with chalk powder filling baskets, carrying and disposing of all excavated materials at a safe distance designated by the E-I-C in all types of soils except rocky, gravelly, slushy or organic soil, leveling, ramming, dressing and preparing the base, etc. all complete for an initial excavation depth of 2m and an initial lead not exceeding 20m, including arranging all necessary tools and equipment at work site, etc. complete as per direction of the E-I-C.	cum	Main wall	17	0.25	0.3	1.275	1	1.28		
				Verandah wall	8.35	0.25	0.3	0.62625	1	0.63		
				Partition wall	2.9	0.25	0.3	0.2175	1	0.22		
				Toilet & Kitchen	9.5	0.25	0.3	0.7125	1	0.71		
									2.83	88.00	249.15	
2	PWD CES02.16.4.1	Earth filling inside plinth in 150mm layers with earth available within 90m of the building site, watering, leveling and consolidating each layer up to finished level, etc. all complete as per direction of the E-I-C..	cum	Room 1	2.74	2.93	0.15	1.20423	1	1.20		
				Room 2	2.82	2.93	0.15	1.23939	1	1.24		
				Varanda	5.62	1.33	0.076	0.5680696	1	0.57		
				Kitchen & toilet	3.8	1.92	0.076	0.554496	1	0.55		
									3.57	302.00	1076.99	
3	PWD CES 03.1	One layer of brick flat soling in foundation or in floor with first class or picked jhama bricks including preparation of bed and filling the interstices with local sand, leveling etc. complete and accepted by the Engineer -in-charge.	sqm	Room 1	2.74	2.93		8.0282	1	8.03		
				Varanda	5.62	1.33		7.4746	1	7.47		
				Kitchen & toilet	3.8	1.92		7.296	1	7.30		
				Room 2	2.82	2.93		8.2626	1	8.26		
									31.06	420.00	13045.79	
4	Analysis	Mass concrete (1:3:6) in foundation or floor with cement, sand (F.M. 1.2) and picked jhama chips including breaking chips, screening, mixing, laying, compacting to levels and curing for at least 7 days including the supply of water, electricity and other charges and costs of tools and plants etc. including NCF in floor, all complete and accepted by the Engineer -in- charge. (Cement: CEM-II/A-M)	cum	Room 1	2.74	2.93	0.075	0.602115	1	0.60		
				Room 2	2.82	2.93	0.075	0.619695	1	0.62		
				Varanda	5.62	1.5	0.075	0.63225	1	0.63		
				Kitchen & toilet	3.8	2.05	0.075	0.58425	1	0.58		
									2.44	6579.00	16041.64	

[Signature]
08.10.20
মোঃ ইসতিয়াক নাসির
সহকারী প্রকৌশলী
আশ্রয়ণ-২ প্রকল্প
প্রধানমন্ত্রীর কার্যালয়।

[Signature]
08.10.20
মোঃ মাহবুব হোসেন
প্রকল্প পরিচালক (অতিরিক্ত সচিব)
আশ্রয়ণ-২ প্রকল্প
প্রধানমন্ত্রীর কার্যালয়।

[Signature]
08.10.20
মোঃ রফিকুল ইসলাম
সহকারী প্রকৌশলী
আশ্রয়ণ-২ প্রকল্প
প্রধানমন্ত্রীর কার্যালয়।

[Signature]
08.10.20
মোঃ রফিকুল ইসলাম
সহকারী প্রকৌশলী
আশ্রয়ণ-২ প্রকল্প
প্রধানমন্ত্রীর কার্যালয়।

[Signature]
08.10.20
মোঃ মাহবুব হোসেন
প্রকল্প পরিচালক (অতিরিক্ত সচিব)
আশ্রয়ণ-২ প্রকল্প
প্রধানমন্ত্রীর কার্যালয়।

5 PWD CES 04.1	250mm brick work with 1st class bricks in cement mortar (1:6) in foundation and plinth with Portland Composite cement (CEM II/AM, 42.5N) and best quality sand (minimum FM1.2), filling the interstices tightly with mortar, raking out joints, cleaning and soaking bricks at least for 24 hours before use, washing of sand, curing for requisite period, etc. all complete as per direction of the E-I-C.	cum	Main foundation	17	0.25	0.45	1.9125	1	1.91	
			Verandha foundation	8.35	0.25	0.3	0.62625	1	0.63	
			partition wall	2.9	0.25	0.45	0.32625	1	0.33	
			Kitchen & toilet	9.5	0.25	0.3	0.7125	1	0.71	
			Stair(3'x2'-6")	0.9	0.76	0.3	0.2052	1	0.21	
			Pillar 1	2.59	0.25	0.25	0.161875	6	0.97	
			Pillar 2	1.83	0.25	0.25	0.114375	5	0.57	
									5.33	6040.00
6 PWD CES 04.15	125mm brick work with Kiln 1st class bricks/automatic machine made 1st class bricks in cement mortar (1:6) with machine made 1st class bricks in cement mortar (1:6) with machine made 1st class bricks in cement mortar (1:6) with Portland Composite cement (CEM II/AM, 42.5N) and best quality sand (minimum FM1.2) and making bond with connected walls with uniform width and depth joints, true to vertical and horizontal lines in/c necessary scaffolding, raking out joints, cleaning and soaking the bricks at least for 24 hours before use, washing of sand, curing for requisite period, etc. all complete as per direction of the E-I-C.	sqm	Main wall	2.59	2.69		6.9671	3	20.90	
				5.18	2.59		13.4162	2	26.83	
			Kitchen & toilet	1.82	2.05		3.731	2	7.46	
				3.6	1.9		6.84	1	6.84	
				1.22	2		2.44	3	7.32	
			door	0.91	1.82		1.6562	-3	-4.97	
				0.76	1.82		1.3832	-1	-1.38	
			Window	0.76	1.06		0.8056	-5	-4.03	
			Mark A						58.98	917.00

Asthaq
08/10/20
মোঃ ইসতিয়াক নাসির
সহকারী প্রকৌশলী
আশ্রয়ণ-২ প্রকল্প
প্রধানমন্ত্রীর কার্যালয়।

Chy
08/10/20
মোঃ আনোয়ার রহমান
উপ-প্রকল্প প্রকৌশলী
আশ্রয়ণ-২ প্রকল্প
প্রধানমন্ত্রীর কার্যালয়
Daha
08.10.20
হিমাদ্রি সাহা
সহকারী প্রকৌশলী
আশ্রয়ণ-২ প্রকল্প
প্রধানমন্ত্রীর কার্যালয়

Ltr
08.10.20
মোঃ রফিকুল ইসলাম
সহকারী প্রকৌশলী
আশ্রয়ণ-২ প্রকল্প
প্রধানমন্ত্রীর কার্যালয়

Amir
08/10/20
আবুল কালাম আজাদ
প্রকল্প প্রকৌশলী
আশ্রয়ণ-২ প্রকল্প
প্রধানমন্ত্রীর কার্যালয়

08/10/20

মোঃ মাহবুব হোসেন
প্রকল্প পরিচালক (অতিরিক্ত সচিব)
আশ্রয়ণ-২ প্রকল্প
প্রধানমন্ত্রীর কার্যালয়

7 PWD CES 07.1.3 RCC:1:2:4, 17MPa, Brick Chips (BC): Reinforced cement concrete works cum Lintel 1.07 0.127 0.15 0.0203835 6 0.12

with minimum cement content relates to mix ratio (tentative 1:2:4) and maximum water cement ratio 0.45 having minimum required average strength, $f_{cr} = 24$ Mpa and satisfied a specified compressive strength $f_c = 17$ Mpa at 28 days on standard cylinders as per $f_c = 17$ Mpa at 28 days on standard cylinders as per standard practice of Code AASHTO/ASTM and Portland Composite Cement conforming to BDS EN 197-1 : 2003 CEM-II 42.5N sand of minimum FM 1.8 and 20mm down well graded picked brick chips (LAA value and maximum water absorption not exceeding 38 and 15% respectively) conforming to ASTM C 33 or Aggregate Grading Appendix-3 LGED Schedule of Rates or any other International recognized envelop in/c breaking chips and screening through proper sieves, centering, shuttering in position, making shuttering fully leak proof & shuttering with plain 16 BWG steel sheet fitted over 38mm thick wooden plank panels and Standard size Bamboo Props suitably braced, placing of reinforcement in position, mixing the aggregates with standard mixer machine with hopper, fed by standard measuring boxes, maintaining allowable slump of 50mm (without plasticizer) & 75mm to 100mm (when plasticizer use), pouring, casting, compacting by mechanical vibrator machine and curing at least for 28 days, removing centering-shuttering after approved specified time period, i/c cost of additional testing charges of materials and cylinders required. Excluding the cost of reinforcement and its fabrication, welding, coupling, placing, binding etc. Additional quantity of cement and Plasticizer i.e. Water reducing chemical admixture of complying type A under ASTM C 494 to reduce mixing water required for normal workability and to maintain low by the mix design from approved laboratory instruction by the Engineer) Additional quantity of cement to be added if required to attain the strength at the contractor's own cost) etc. all complete as per direction and approval of the Engineer in charge. Note : Using Concrete Mixer. In Tie Beam and Lintel :Below Plinth Level and in Ground Floor

1.22 0.127 0.15 0.023241 3 0.07

1.07 0.076 0.15 0.012198 4 0.05

0.24 7602.00 1830.68

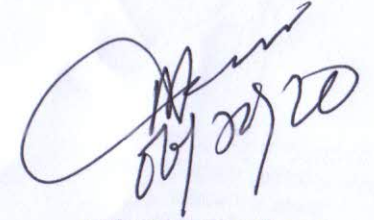

মোঃ মাহবুব হোসেন
প্রকল্প পরিচালক (অতিরিক্ত সচিব)
আশ্রয়ণ-২ প্রকল্প
প্রধানমন্ত্রীর কার্যালয়

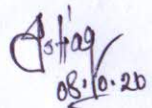

মোঃ ইসতিয়াক নাসির
সহকারী প্রকৌশলী
আশ্রয়ণ-২ প্রকল্প
প্রধানমন্ত্রীর কার্যালয়।

Baha
08.10.20

হিমাদ্রি সাহা
সহকারী প্রকৌশলী
আশ্রয়ণ-২ প্রকল্প
প্রধানমন্ত্রীর কার্যালয়

০৮.১০.২০

মোঃ রফিকুল ইসলাম
সহকারী প্রকৌশলী
আশ্রয়ণ-২ প্রকল্প
প্রধানমন্ত্রীর কার্যালয়

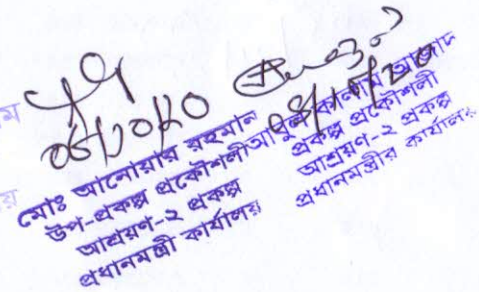

মোঃ আনোয়ার রহমান
উপ-প্রকল্প প্রকৌশলী
আশ্রয়ণ-২ প্রকল্প
প্রধানমন্ত্রীর কার্যালয়

8 PWD CES 08.1.1

Supplying and fabrication of Ribbed or deformed barreinforcement for all kg types of RCC work includingstraightening, removing ruts, cleaning, cutting, hooking, bending, lapping and/or welding wherever required as directed, placing in position, tying with 22 BWG black annealed binding wire (PVC coated in case of FBEC rebar)double fold, cost of binding wire and anchoring to the adjoining members wherever necessary, supplying and placing with proper cover blocks (1:1), supports, chairs, spacers, splices or laps etc. including cost of all materials, cost of labour, cost of equipment & machinery, loading and unloading, transportation, all other incidental charges and work at all leads and lifts etc. to complete thework as per design, drawing, specifications and direction of the E-I-C. Measurement relating to nominal mass, dimensions and tolerances of various types of steel shall conform to relevant BDS/ ASTM codes. Reinforcement shall be measured only in lengths of bar as actually placed in position on standard weight i.e. 7850 kg/m3 (BNBC Table 6.2.1) basis. No separate payment shall be allowed for Chairs of any shape & profile, spacer bar of any shape & profile, lap/ splice unless otherwise shown in the drawing, wastages, binding wire, concrete cover blocks etc. as the cost of these is included in the unit rate. Note: Tests for reinforcing bars shall be conducted at LGED/ BUET/ CUET/ KUET/ RUET.Grade 300 (RB 300): Ribbed or Deformed bar produced and marked as per BDS ISO 6935-2:2006 with minimum yield strength, fy (ReH) = 300 MPa, but the tested yieldstrength shall not exceed fy by more than the 125 MPa and the ratio of tested ultimate strength, fu (Re) to tested elongation after fracture (A5.65) & minimum total elongation at maximum force (Agt) is 16% and 2.5% respectively.

Main bar(dia-10mm)	1.22	0.62	0.7564	12	9.08
	1.06	0.62	0.6572	30	19.72
Stirrup(dia-8mm)	0.45	0.39	0.1755	90	15.80
				44.59	79.00
					3522.44

[Signature]
 মোঃ মাহবুব হোসেন
 প্রকল্প পরিচালক (অতিরিক্ত সচিব)
 আশ্রয়ণ-২ প্রকল্প
 প্রধানমন্ত্রীর কার্যালয়

[Signature]
 মোঃ আনোয়ার হুসাইন
 উপ-প্রকল্প প্রকৌশলী
 আশ্রয়ণ-২ প্রকল্প
 প্রধানমন্ত্রীর কার্যালয়

9 Analysis

Supplying and making well matured natural seasoned solid wood works cum Wall plate in frames of roof truss of required length and size with wall plates as per design in/c length and size with wall plates as per design in/c supplying, fabricating, hoisting, scaffolding, fitting and fixing in position with bolts and nuts for all floors etc. all complete as per direction of the E-I-C. (All sizes of wood are finished).Mehagoni/Shishu/Local sai/Silkaraí or loacally available equivalent quality wood

Wall plate	18	0.05	0.05	0.045	1	0.05
Tie beam	3.078	0.075	0.05	0.0115425	4	0.05
Rafter	2.006	0.05	0.05	0.005015	8	0.04
Rafter(Verandha)	1.89	0.05	0.05	0.004725	8	0.04
Wall plate for varanda	5.94	0.05	0.05	0.01485	1	0.01
Purline(Varanda)	6.25	0.05	0.025	0.0078125	3	0.02
Tie Triangle portion	2.49	0.05	0.05	0.006225	4	0.02
Triangle Portion rafter	1.041	0.05	0.05	0.0026025	8	0.02
Triangle portion for rafter(av)	0.899	0.05	0.05	0.0022475	8	0.02
Tie for ridge	2.438	0.05	0.05	0.006095	1	0.01
Purlin(long chala)	3.944	0.05	0.025	0.00493	8	0.04

[Signature]
 আবুল কালাম আজাদ
 প্রকল্প প্রকৌশলী
 আশ্রয়ণ-২ প্রকল্প
 প্রধানমন্ত্রীর কার্যালয়

[Signature]
 মোঃ ইসতিয়াক নাসির
 সহকারী প্রকৌশলী
 আশ্রয়ণ-২ প্রকল্প
 প্রধানমন্ত্রীর কার্যালয়।

[Signature]
 বাহা
 08.10.20
 হিমাদ্রি সাহা
 সহকারী প্রকৌশলী
 আশ্রয়ণ-২ প্রকল্প
 প্রধানমন্ত্রীর কার্যালয়

[Signature]
 08.10.20
 মোঃ রফিকুল ইসলাম
 সহকারী প্রকৌশলী
 আশ্রয়ণ-২ প্রকল্প
 প্রধানমন্ত্রীর কার্যালয়

Purline(short chala)(av)	2.438	0.05	0.025	0.0030475	6	0.02
Latrine wall plate	7.83	0.05	0.05	0.019575	1	0.02
Rafter(latrine)	2.28	0.05	0.05	0.0057	6	0.03
Purline(latrine)	4.22	0.05	0.025	0.005275	3	0.02
	0.40	42958.73		17376.70		

10 Analysis

Supplying, fitting and fixing steel window shutter with frames & grill as per drawing & design having requisite Nos. of vertical and horizontal standard MS angle(19mmx19mmx3mm) and 'Z' section (19mmx19mmx19mmx 3mm) for shutter and MS flat bar (25mmx4.5mm) and (19mmx3mm) and 10mmx10mm (25mmx4.5mm) and (19mmx3mm) and 10mmx10mm square bar welded horizontally @ 125mm at inside face of frame of window shutter with F.I. clamp 75mmx3mm duly embedded in Cement Concrete (1:2:4:) and mending good the damages in/c finishing the intersecting points by filling with all cost of charges for fabrication and manufacture by welding, riveting, etc. supplying all essential fittings like stopper, handle, 3 nos catch hooks, 300mm long adjustable iron cleats, 50mm long pin hinges, 150mm long clamps for fitting frame in/c supplying, fitting, fixing 22 BWG M.S. sheet in positionwelded to steel shutter with (19mmx3mm) MS flat bar stiffener and putty and painting the window with two coats of synthetic enamel paint over a coat of anticorrosive priming, etc for all floors. all complete as per direction

Nos Window

5

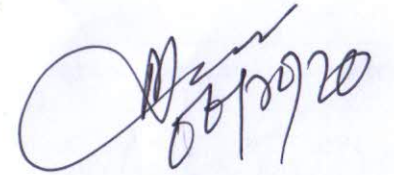

মোঃ মাহবুব হোসেন
প্রকল্প পরিচালক (অতিরিক্ত সচিব)
আশ্রয়ণ-২ প্রকল্প
প্রধানমন্ত্রীর কার্যালয়

5.00 2800.00 14000.00

11 Analysis

Supplying fitting and fixing steel door frame & shutter with 18 BWG MS sheet/plain plate hinged to RCC columns reinforcement with 38mmx38mmx5mm MS Angle and 25mmx6mm flat bar stiffener and putty and painting the wdoor with two coats of synthetic enamel paint over a coat of anticorrosive priming, etc. all complete as per drawing and direction of F-I-C

Nos Door

2

2.00 3500.00 7000.00

12 Analysis

Supplying, fitting, fixing of uPVC hollow or solid plastic door shutter etc. all complete as per drawing and direction of E-I-C.

Nos Door

1

1.00 2000.00 2000.00

13 Analysis

Supplying, fitting and fixing 0.36mm thick galvanized iron corrugated locally available color (Maroon, Blue, Green) sheet (Bangladesh made) having minimum weight 45-50 kg per bundle (2'-6"width 70 - 72 rft long) roofing fitted and fixed on MSsections with 'J' hook or wooden purlins with screws, limpet washers, bitumen washers and putty etc. all complete as per direction of the E-I-C.

sqm Long chala

4.038 2.133

8.613054

2 17.23

Short chala

1.904 1.828

3.480512

2 6.96

Verandha

6.4 1.828

11.6992

1 11.70

Chala for latrine

4.52 2.58

11.6616

1 11.66

464.73 22096.84

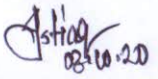
মোঃ ইসতিয়াক নাসির
সহকারী প্রকৌশলী
আশ্রয়ণ-২ প্রকল্প
প্রধানমন্ত্রীর কার্যালয়।

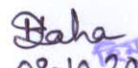
মোঃ বিহা
সহকারী প্রকৌশলী
আশ্রয়ণ-২ প্রকল্প
প্রধানমন্ত্রীর কার্যালয়

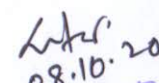
মোঃ রফিকুল ইসলাম
সহকারী প্রকৌশলী
আশ্রয়ণ-২ প্রকল্প
প্রধানমন্ত্রীর কার্যালয়

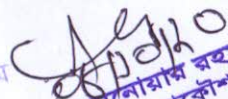
মোঃ আনোয়ার হােক
উপ-প্রকল্প প্রকৌশলী
আশ্রয়ণ-২ প্রকল্প
প্রধানমন্ত্রীর কার্যালয়

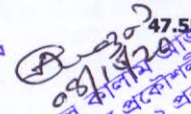
মোঃ কলাম
সহকারী প্রকৌশলী
আশ্রয়ণ-২ প্রকল্প
প্রধানমন্ত্রীর কার্যালয়

14 Analysis	0.46mm (SWG) thick galvanized iron plain sheet ridging with 300mm lap on either side fitted and fixed with galvanized bolts and nuts etc. all complete as per direction of the E-I-C. (Maroon, Blue, Green)	m	Ridge	2.74	2.74	5	13.70		
								13.70	179.71
									2462.05

15 Analysis	Minimum 12mm thick cement plaster (1:6) with Portland Composite cement (CEM II/AM, 42.5N) and best quality sand (minimum FM1.2) to wall both inner and outer surface, finishing the corner and edges in/c washing of sand cleaning the surface, scaffolding and curing for the requisite period etc. all complete as per direction of the E-I-C.	sqm	Mark 'A'				58.98		
-------------	--	-----	----------	--	--	--	-------	--	--

16 PWD CES 07.1.3	White washing by three coats, lime mixture prepared at least 12 hours before use, slacking stone lime, supplying of gums, blue, stirring thoroughly, removing the floating materials from the mixer, surface cleaning to free from all foreign materials before application of each coat, applying one vertical and one horizontal wash for each coat and successive coat is to be applied after drying up of previous coat including hair brass, providing necessary scaffolding and cleaning plinth, floors, doors, windows, portions and ventilators by washing, rubbing, oiling if necessary after white wash for all floors including cost of water, electricity and other charges etc. complete in all respect in all floors and accepted by the Engineer-in-charge.	sqm	Mark 'A'						
-------------------	--	-----	----------	--	--	--	--	--	--

17 Analysis	Construction of single pit latrine, Manufacturing and Supplying of 6 nos RCC ring of 40 mm wall thickness and internal diameter 0.30m of height including RCC slab with pan, footrest, necessary UPvc pipe and trap and earth cutting filling, fixing all necessary fittings etc, all complete as per direction of the E-I-C.	Nos							
-------------	---	-----	--	--	--	--	--	--	--

Mark 'A' X 2 **117.95** **175.89** **20747.05**

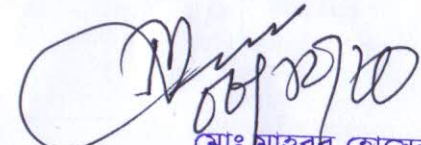
 মোঃ মাহবুব হোসেন
 প্রকল্প পরিচালক (অতিরিক্ত সচিব)
 আশ্রয়ণ-২ প্রকল্প
 প্রধানমন্ত্রীর কার্যালয়

Mark 'A' X 2 **117.95** **22.00** **2594.94**

1 1.00

1.00 **2150.00** **2150.00**

Total **212443.14**

171016.73

Total Amount after deducting Contractor's profit, Vat & IT (10+9.5= 19.5%)

Say Total Amount= 1,71,000.00 Taka

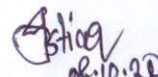
 মোঃ ইসতিয়াক নাসির
 সহকারী প্রকৌশলী
 আশ্রয়ণ-২ প্রকল্প
 প্রধানমন্ত্রীর কার্যালয়।

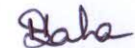
 08-10-20
 হিমাত্রি সাহা
 সহকারী প্রকৌশলী
 আশ্রয়ণ-২ প্রকল্প
 প্রধানমন্ত্রীর কার্যালয়

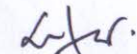
 08.10.20
 মোঃ রফিকুল ইসলাম
 সহকারী প্রকৌশলী
 আশ্রয়ণ-২ প্রকল্প
 প্রধানমন্ত্রীর কার্যালয়

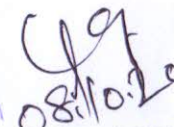
 08/10/20
 মোঃ আনোয়ার রহমান
 উপ-প্রকল্প প্রকৌশলী
 আশ্রয়ণ-২ প্রকল্প
 প্রধানমন্ত্রীর কার্যালয়

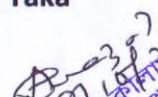
 08/10/20
 আবু ফারুক
 প্রকল্প প্রকৌশলী
 আশ্রয়ণ-২ প্রকল্প
 প্রধানমন্ত্রীর কার্যালয়